



THULE[®]
SWEDEN

PROFESSIONAL

**The load carrier system
designed for professionals**

The rugged time-saving system

Thule Professional is a load carrier system from the world leader in utility transportation. Every aspect of the system, including each component and selected material, is thoroughly researched and tested – and ready for heavy-duty action. The result is a flexible and time-saving system capable of meeting your unique requirements safely and easily for a long time to come. So find the solution that is perfect for you. Just mix, match and attach.

All products have been designed to be ergonomic, to avoid injury and make loading, unloading and transportation safer.

Thule Professional ladder carriers include smart solutions for the safe and easy transport of all kinds of ladders – saving your back and saving your time.

The Thule Conduit Box 317 is a perfect solution for safely and conveniently transporting pipes up to 3 metres long.

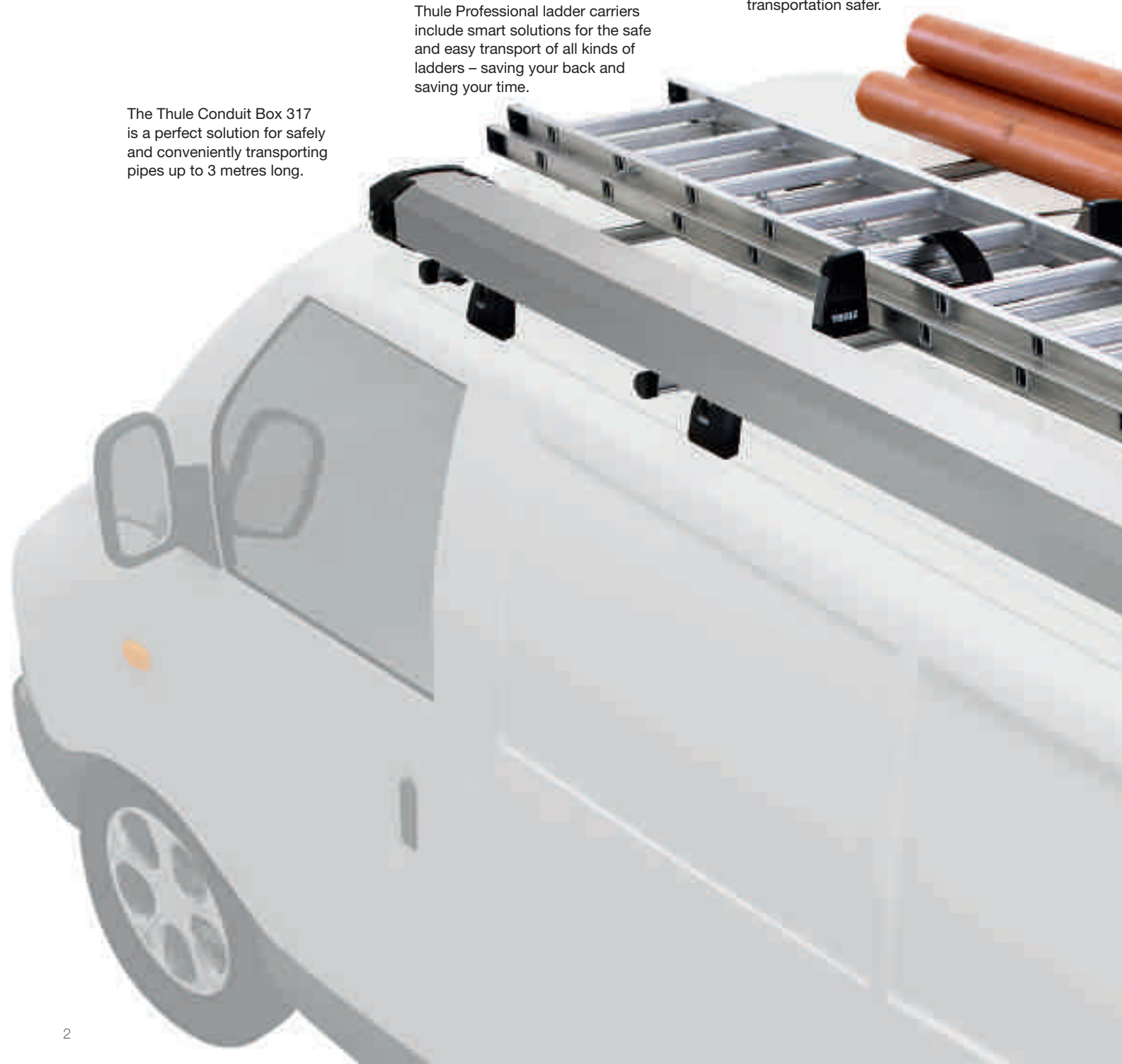

Content

The rugged time-saving system	2-3
Advantages of Thule Professional	4-5
Load Carriers	6-7
Ladder Carriers	8-11
Pipe Carrying Solutions (and other loads)	12-15
Load Stops and Accessories	16-19
Awnings / Weather protection	20
Technical information	21-23

Robust and functional load stops keep boards, planks and other bulky loads in place. Easy to attach and adjust for maximum ease of use.

Thule Professional is an integrated load carrier system that offers everything you need for safe and convenient transport on the job.



The van is equipped with:
Thule Conduit Box 317
Thule Ladder Holder 330
Thule Fold Down Load Stops 315
Thule Ratchet Tie Down 323



The advantages are obvious

All the products and parts in the Thule Professional range have been developed, designed and manufactured specifically for professional use under tough conditions. The robust aluminium design and high quality ensure a really long life. The system's flexibility allow you to create the perfect transport solution that meets all your needs. The advantages of Thule Professional will become clear on closer inspection.



It's Easy

Thule's development philosophy is based on finding simple, time-saving solutions for every specific transport requirement. If you are loading and unloading your equipment several times a day, Thule Professional will help you save valuable time that you can use for work and improved efficiency. Within a short time your investment in a Thule Professional load carrier system will be repaid.

It's Durable

Every product in the Thule Professional range has undergone comprehensive tests including heat/cold, UV, corrosion, endurance testing etc. We test functionality, user-friendliness and product safety. All materials have been carefully selected on the basis of criteria such as safety, ease and durability. This is why we offer a five-year guarantee for all products in the Thule Professional range.

5 *års garanti*
years warranty
Jahre Garantie
ans de garantie

It's Safe

To reassure ourselves that the products can withstand really extreme loads, they are subjected to the very toughest testing. They are also adapted according to the City Crash standard. The City Crash test is a method of testing products according to the ISO standard as well as DIN standard 75302. Adapting products to the City Crash standard is an important part of our safety-oriented approach.

CITY CRASH

Complies with *new* DIN/ISO norm

Start with the base in Thule's dynamic platform

It all starts here. The Thule load carrier is the base in the dynamic platform for carrying your professional load. The unique design enables the fitting of multiple accessories, adapting to your needs and way of working. It is built tough in every detail using light, highly robust aluminium and advanced polymer materials – proven to take professional beatings and have a long life.



Fits all kinds of work vans

As all work vans have a different roof design, we have developed different kits of load carrier feet for a perfect fit on every kind of roof. All you need to know to get your complete professional load carrier is the make, model and year of your van. See the Thule Professional Fit Guide.

Tested and approved for really heavy loads

The Thule Heavy-Duty Bar has been tested and approved to ISO standards and is designed to take a hefty 50 kg load on each bar, i.e. 200 kg if you have four bars mounted. The aerodynamic design of the Heavy-Duty Bar means minimum wind resistance for better fuel economy.



5 års garanti
years warranty
Jahre Garantie
ans de garantie



CITY CRASH
Complies with *new* DIN/ISO norm

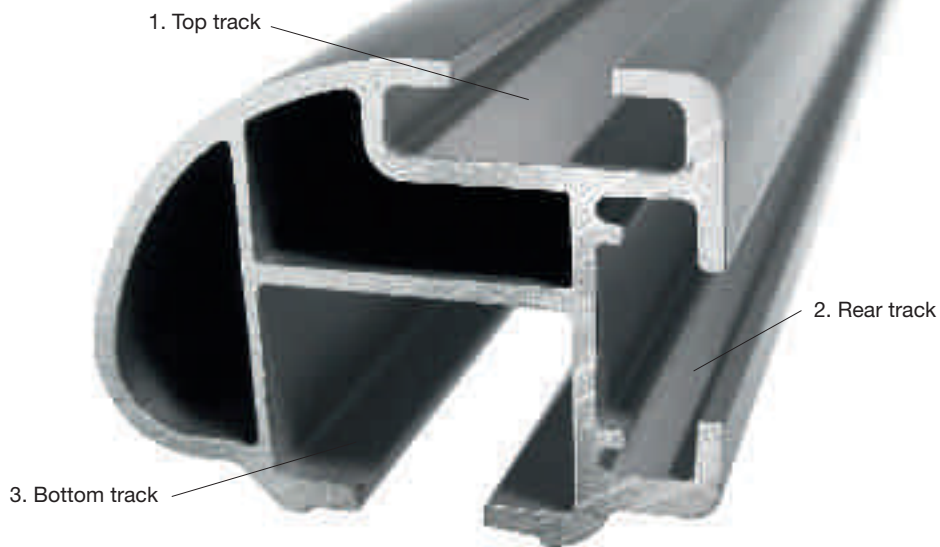

The unique Thule tri-slot design opens up all sorts of possibilities

The Thule Heavy-Duty Bar has a smart tri-slot design. This gives great flexibility and opens up the possibility of combining a range of different accessories that can be used independently of each other or together. Below, you can see a few examples of how to make the most of this smart design.

1. Top track

In the top track, you can fit e.g. the Thule Load Stop, Thule Ladder Tilt, Thule Ladder Holder etc. You mount it in just a few seconds. Just slide it in and lock.



2. Rear track

In the rear track you can very easily change between Thule Roller, Thule Foldable Load Stop and Thule Eye bolt. Or let them be mounted together! And you will have the top of the Thule Heavy-Duty Bar free for your load.

3. Bottom track

The bottom track is used to slide the load carrier feet into the bar. The T-track design also allows you to use longer bars, so you can decide how much projection you need for a load or other Thule Professional products (e.g. Thule Awning 326-328 or Thule Conduit Box 317).



How about some help with loading the ladder?

How many times a day do you load ladders on and off the vehicle roof? And how does your back feel in the evening? To save both your back and your valuable time, Thule has developed ladder holders and a Roller Extension that help you with the loading process.



The ladder carriers that saves your back and your time

Thule Ladder Tilt 311 is a smart ladder transport solution that enables you to load your ladders onto the roof of your vehicle without straining your back. Simply pull out the carrier from the roof and tilt it down to a more easily accessible and ergonomic height. There's no need to stretch over the vehicle roof to fix your ladders in place, and it all takes a matter of seconds. Another easily handled ladder carrier is the Thule Ladder Holder 330, which features the same unique fastening solution as the Thule Ladder Tilt 311.



Thule Ladder Tilt 311

Designed with an innovative extender function that tilts down along the side of the vehicle, making loading and unloading remarkably quick, easy and safe. A ratchet mechanism with a wide and durable rubber strap ties down the ladder comfortably and safely. Material: aluminium. Quick strap. Load capacity 50 kg/3-part extension ladders. The Thule Ladder Step Adapter 310 is included for use when the steps are off-centre.

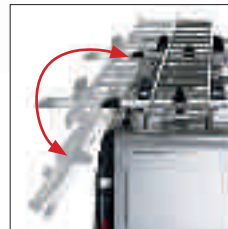

Just tilt down and load the ladder.



Quick and easy fastening with ratchet mechanism.



Smart pull-out function
The Thule Ladder Tilt 311 can be pulled out from the roof and tilted down the side of the vehicle, giving you a comfortable loading height. Once you've loaded and secured the ladders, simply slide the ladder carrier back up onto the roof.



Thule Ladder Holder 330

Easily handled ladder carrier with a unique ladder fixing, for quick and easy loading and unloading. The Thule Ladder Holder 330 is equipped with a unique fastening solution based on wide and robust straps with a ratchet mechanism for quick and easy loading and unloading. A set consists of 2 strap mechanisms and 4 load stops.



Quick and easy fastening with ratchet mechanism.



Easy to convert the ladder carriers to carry other items.

+ Add-on

Thule Ladder Step Adapter 310

Useful accessory when the ladder pins/ ladder steps do not correspond with the ladder holder (depends on ladder type and car).



Thule Roller 334/335

Makes it very easy to load up ladders, planks and other long objects. Simply "roll" the load up onto the roof. Easily mounted in the rear T-track of Thule Heavy-Duty Bar.



Thule Roller Extension 340

The accessory that makes loading and unloading easier – and at the same time protects the vehicle roof – thanks to an integrated roller. Easy to adjust forwards and backwards so that the roller is level with the rear edge of the roof. Mounts under the roof bar, leaving the top and rear T-tracks free for other Thule Professional accessories.





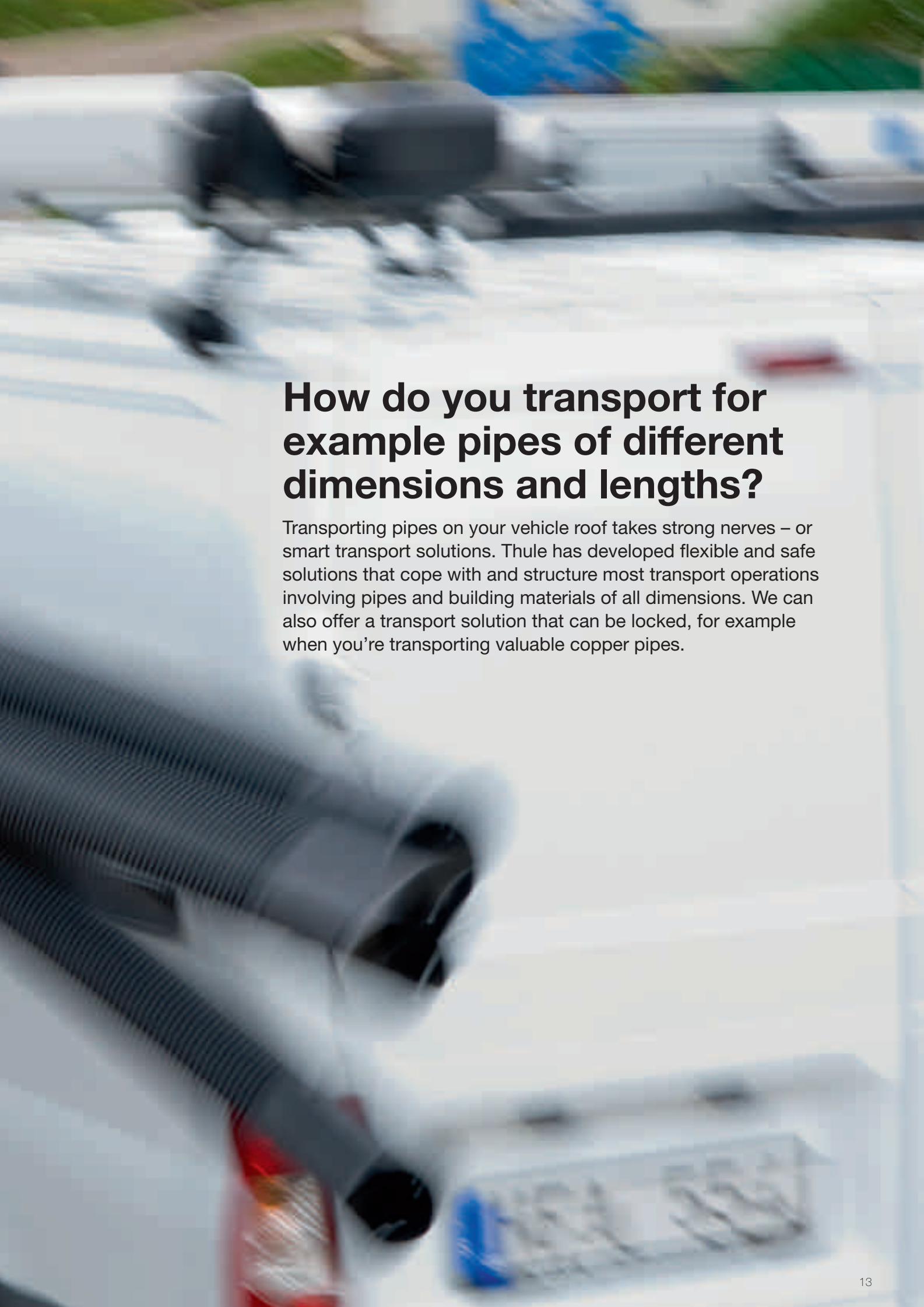

How do you transport for example pipes of different dimensions and lengths?

Transporting pipes on your vehicle roof takes strong nerves – or smart transport solutions. Thule has developed flexible and safe solutions that cope with and structure most transport operations involving pipes and building materials of all dimensions. We can also offer a transport solution that can be locked, for example when you're transporting valuable copper pipes.

Thule Conduit Box protects your pipes the safest possible way

The Thule Conduit Box 317 takes care of a few of the most annoying aspects of loading pipes and similar objects. In fact, loading and transporting pipes has never been easier. The Thule Conduit Box 317 is lockable, so the pipes are safe and secure during transport and theft is more difficult. By adding a movable midwall, you can also separate long and short pipes. For really long pipes and other long items we have developed a new, flexible solution: the Thule Front Stop 321 in use with Thule Side Profiles 322.



Lockable snaplocks



Thule Conduit Box 317

This is the perfect solution for safely and conveniently transporting pipes. Constructed in brushed stainless steel, it has double openings to make loading and unloading your pipes easy. The box closes up using lockable snaplocks. Takes pipes up to 3 metres long.

+ Add-on

Thule Box Midwall 318

The midwall and a wire trace allow you to separate short and long pipes. Storing different lengths of pipe in separate spaces avoids the problem of short pipes “disappearing” into the front of the box. Use the wire trace to pull out your pipes.



Wire trace



Thule Front Load Stop System – for safe transportation of loads up to 6 metres

The modular system allows you to create your own safe carrier solution for bulkier loads. Start with a Thule Front Stop 321 and then choose Thule Side Profiles 322 to create the length you need. An excellent complement to the Thule Conduit Box 317 if you want to carry pipes over 3 metres long or you have larger diameters.



Two straps with the new safe and easily handled U-bolt solution, which fasten in one simple operation, are included.

Thule Front Stop 321

This safety accessory is easy to fit and made from a durable and protective polymer. City Crash tested and approved due to crash plate behind plastic shield. Two special Ratchet Tie Downs for the Thule Side Profiles 322 are included to secure the load. (Needs to be combined with Thule Side Profiles 322 to adjust to your car/load length).

Thule Side Profiles 322

Using the side profiles, available in 1.5 metre lengths, you can create exactly the load carrier solution you need. Can be combined to accommodate loads of up to 6 metres with a maximum weight of 100 kg. (Needs to be combined with Thule Front Stop 321).

<p>Front Stop + 2 Side Profiles = 75 kg load capacity on vehicles with 2 load bars.</p>	<p>You choose how long your Front Load Stop should be. With the right number of load carriers, you can transport pipes, timber etc. up to a length of 6 metres (carspecific).</p>
<p>Front Stop + 3 Side Profiles = 100 kg load capacity on vehicles with 3 load bars.</p>	
<p>Front Stop + 4 Side Profiles = 100 kg load capacity on vehicles with 4 load bars.</p>	

+ Add-on

Thule Roller 336

This specialist accessory makes it easy to load long objects such as long pipes, planks etc. onto the Thule Front Load Stop. Simply “roll” up the load and secure it. (To be combined with Thule Side Profiles 322 only).



Can you load your vehicle roof both quickly and safely?

You know how tricky it can be to secure timber or other material to your vehicle roof. We've solved the problem by developing unique sliding and foldable load stops that keep boards, planks and other materials in place and do not interfere when loading – easy to handle and adjust precisely to the space required by the load.

In addition Thule Tie Downs and Thule Eyebolts allow you to secure your load easily. To protect the rear of the car and make loading easier we provide single Rollers or an integrated Roller in a load bar extension.



Thule's ways to simplify loading and keep load under control

Thule Professional products are perfect examples of our philosophy: creative thinking, technological innovation and safety. And, last but not least, our products save you time.

Thule Fold Down Load Stop 315

Unique patented load stop that simply folds out of the way when loading, unloading or when not in use. Easy sideways adjustment through tilt mechanism – when folded upwards it keeps your load firmly in place. To be mounted preferably into rear T-track of the Thule Heavy-Duty Bar.

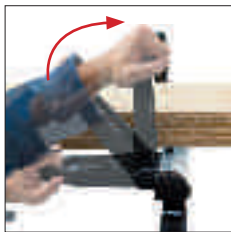

Tilt function for easy loading and unloading.



Easy to move for adjusting according to type and width of load.

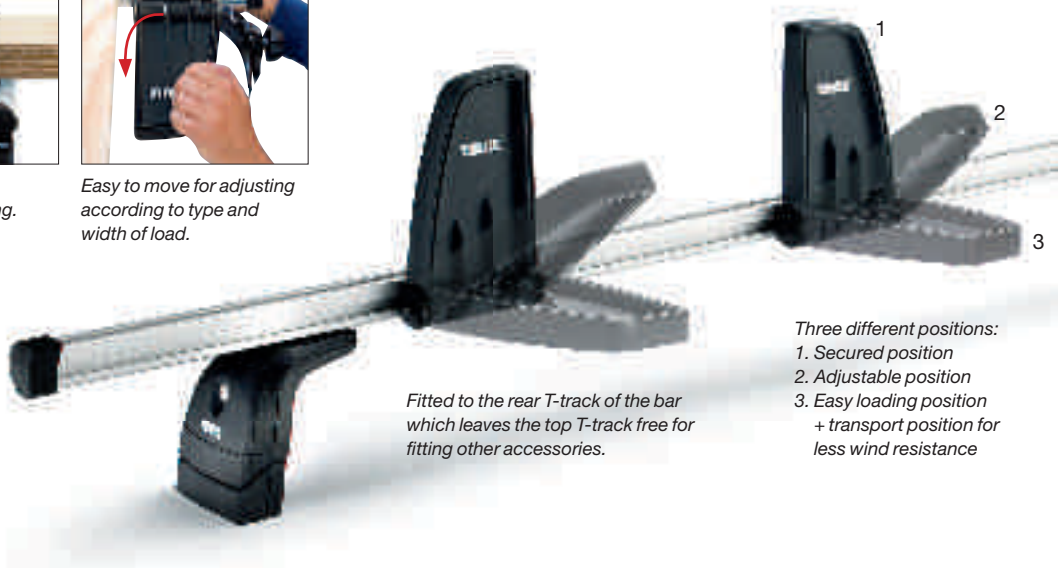

Fitted to the rear T-track of the bar which leaves the top T-track free for fitting other accessories.

- Three different positions:*
- 1. Secured position*
 - 2. Adjustable position*
 - 3. Easy loading position + transport position for less wind resistance*





Thule Load Stop 314

Robust and functional load stop that keeps the load firmly in place and prevents it from sliding. Easy to attach and adjust for maximum ease of use. Easy-grip lever for the easiest possible adjustment. To be mounted in the top T-track of the Thule Heavy-Duty Bar.



Easy to move for adjusting according to type and width of load.



Thule Ratchet Tie Down 323

Ensures speedy and secure fastening of loads, from ladders to planks. Consists of 2 parts: 4.1m and 0.4m strap with S-hooks in steel. Ideal for use with Thule Eye Bolt 320.

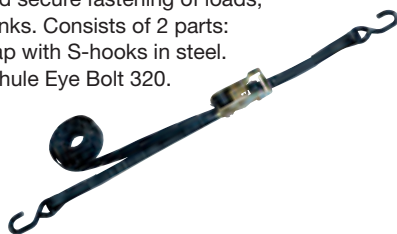

Thule Eye Bolt 320

Mounts in any T-slot of the Thule Heavy-Duty bar. Secure your load by using the Eye Bolt and the Ratchet Tie Down. Ideal for use with Thule Ratchet Tie Down 323.



+ Add-on

Thule Roller 334/335

This accessory makes it easier to load up ladders, planks and other long objects. Simply "roll" the load up onto the roof. Easily mounted in the rear T-track of the Thule Heavy-Duty Bar.



Thule Roller Extension 340

The accessory that makes loading and unloading easier – and at the same time protects the vehicle roof – thanks to an integrated roller. Easy to adjust forwards and backwards so that the roller is level with the rear edge of the roof. Mounts under the roof bar, leaving the top and rear T-tracks free for other Thule Professional accessories.



Don't let the weather stop you from working

Sometimes it's the sun beating down, sometimes it's the rain. Whatever the weather, the Thule Professional Awning will not let it interrupt your work. It fits easily along the side of the vehicle and rolls out when the weather turns nasty – it then rolls away just as easily when it's all over.



Thule Awning 326/327/328

Mounted to the roof bars, the Thule Awning rolls out along the side of the vehicle. It is made of aluminium profiles, and has a durable weatherproof and PVC-laminated fabric which is also UV-resistant. As it is available in lengths from 2.6 to 3.5m the Awning will fit most work vans. Smart, adjustable legs integrated in the front profile give more clearance and stability when in use. The legs are also attachable to the vehicle with Thule Awning Adapter 347

Thule Awning Adapter 347

Use this adapter to attach the legs of the Thule Awning to the side of the vehicle – in situations where you have no stable ground or are working next to a hole.



Thule Heavy-Duty Bars



Name	Thule Heavy-Duty Bar	Thule Heavy-Duty Bar	Thule Heavy-Duty Bar	Thule Heavy-Duty Bar	Thule Heavy-Duty Bar	Thule Heavy-Duty Bar
Item number (2 pieces)	390	391	392	393	394	395
Item number (1 piece)	3901	3911	3921	3931	3941	3951
Length (cm)	120	135	150	175	200	220

Thule Foot packs for Heavy-Duty Bars

For vehicles with built-in fixpoints.



For vehicles with roof rails.



For vehicles with normal roof.



For vehicles with rain gutter.



Name	Thule Rapid Fixpoint XT	Thule Rapid Fixpoint XT Low	Thule Rapid Crossroad	Thule Rapid Railing	Thule Rapid System	Thule Gutter Foot		
Item number (4 pieces)	751	753	775	757	750	9511/9512	9521/9522	9531
Item number (2 pieces)	7511	7531						
Load capacity, per pairs of bars (kg) ¹	100	100	100	100	75	100	100	100
Foot height (cm) ²	9,5	5,2	5,5	7,5	14	15	20	28
Lock	•	•	•	•		Accessory 527	Accessory 527	Accessory 527
Fitting kit needed	•	•			•			
Tool key 379 needed					•			
TÜV approved	•	•	•	•	•	•	•	•
Meets City Crash standard	•	•	•	•				
Miscellaneous			Railing sizes 20-68 mm	Railing sizes 22-55 mm				

¹ Maximum load is the maximum approved weight for each type of load carrier. Consult your car manual for your car's maximum load limit. ² Foot height is the distance from the base of the foot to the top of the bar. Please note: for distances to the bottom of the bar, deduct 27 mm for heavy-duty bar.

Thule Awnings



Name	Thule Awning 326	Thule Awning 327	Thule Awning 328
Length of product (cm)	260	300	350
Projection (cm)	200	250	250
Length of support-legs (cm)	179	219	268
Material	Aluminium and tear resistant fabric in laminated PVC	Aluminium and tear resistant fabric in laminated PVC	Aluminium and tear resistant fabric in laminated PVC
Recommended add-on product	347 for fixing the legs to the vehicle	347 for fixing the legs to the vehicle	347 for fixing the legs to the vehicle
Miscellaneous	Crank included. 3 load bars required.	Crank included. 3 load bars required.	Crank included. 3 load bars required.

Thule Ladder Carriers

<p>Thule Ladder Tilt 311 Designed with an innovative extender function that tilts down along the side of the vehicle, making loading and unloading remarkably quick, easy and safe.</p> 	<p>Thule Ladder Holder 330 Features a unique fastening solution based on robust straps with a ratchet mechanism for quick and easy loading and unloading.</p> 	<p>Thule Ladder Step Adapter 310 Useful accessory when the ladder pins/ladder steps do not correspond with the ladder holder (depends on ladder type and car).</p> 
--	---	---

Name	Thule Ladder Tilt 311	Thule Ladder Holder 330	Thule Ladder Step Adapter 310
Load capacity (kg)	50	50	
Material	Aluminium, Advanced, durable polymer	Advanced, durable polymer	Steel tube with foam protection
Recommended Add-on product		Thule Roller Extension 340, Thule Ladder Step Adapter 310	
TÜV approved	•	•	•
Meets City Crash standard	•	•	
Miscellaneous	Pad lock facilities for locking ladder and carrier included. Thule Ladder Step Adapter 310 included.	Consists of 4 load stop and 2 ratchet mechanisms.	For use with Thule Ladder Tilt 311, Thule Ladder Holder 330.

Thule Conduit Box, Front Load Stop System

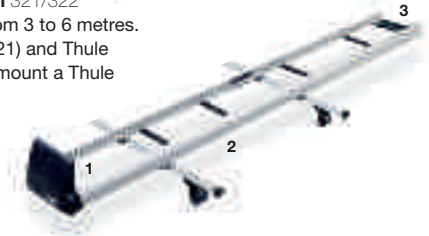
<p>Thule Conduit Box 317 Designed with double openings making loading and transporting pipes amazingly quick and easy.</p> 	<p>Thule Front Load Stop System 321/322 With capacity for pipe length from 3 to 6 metres. Consists of Thule Front Stop (321) and Thule Side Profiles (322). Possible to mount a Thule Roller (336) to end section.</p> 
---	--

1. Thule Front Stop 321
2. Thule Side Profiles 322
3. Thule Roller 336



Name	Thule Conduit Box 317	Thule Front Stop 321	Thule Side Profile 322
Load capacity (cm)	320 x 22 x 12	33x20	150 x 30
Material	Brushed, stainless steel.	Crash resistant front steel plate with a plastic cover.	Aluminium side plate with steel center rods.
Load capacity (kg)	50	100 with 3 Heavy-Duty Bars, 75 with 2 Heavy-Duty Bars	100 with 3 Heavy-Duty Bars, 75 with 2 Heavy-Duty Bars
Recommended Add-on product	Thule Box Midwall 318 with wire trace allow you to separate short and long pipes.	Thule Roller 336	Thule Roller 336
TÜV approved	•	•	•
Meets City Crash standard	•	•	•
Miscellaneous	Mounts around the Thule Heavy-Duty Bar and square bars (U-bolt mounting hardware). Integrated lock.	Is attached to the rear T-track of the Thule Heavy-Duty Bar. Mounts around square bars with accessory 346. Two special Ratchet Tie Downs included. Needs to be combined with Thule Side Profile 322.	Is attached to the rear T-track of the Thule Heavy-Duty Bar. Mounts around Thule Square Bars with accessory 346. Needs to be combined with Thule Front Stop 321.



Find your Load Carrier in the Fit Guide on our website



All you need to know is the make, model and year of your work van – then simply follow the recommendations presented in our Fit Guide. This is what you need to build a load carrier system to meet your specific needs and your way of working.

Thule Load Stops

<p>Thule Fold Down Load Stop 315 Keeps the load firmly in place, while offering a unique folding capability, so that it can be tilted down when not in use or when loading.</p> 	<p>Thule Load Stop 314 A durable, quickly attached solution that firmly positions the load and prevents sliding, while being easy to adjust.</p> 
--	--

Name	Thule Fold Down Load Stop 315	Thule Load Stop 314
Height (cm)	17	15
Material	Advanced, durable polymer	Advanced, durable polymer
Recommended Add-on product	Thule Ratchet Tie Down 323, Thule Eyebolt 320	Thule Ratchet Tie Down 323, Thule Eyebolt 320
TÜV approved	•	•
Miscellaneous	Mounts to the rear T-track of the Thule Heavy-Duty Bar	Mounts to the top T-track of the Thule Heavy-Duty Bar

Thule Rollers, Roller Extension

<p>Thule Roller 334/335 Makes loading of longer items such as ladders and planks a lot easier, while helping to protect the top and back of the vehicle.</p> 	<p>Thule Roller 336 Special accessory for Thule Front Load Stop 321/322, makes loading of longer items such as pipes, planks etc. a lot easier, while helping to protect the back of the vehicle.</p> 	<p>Thule Roller Extension 340 Extends the roof rack for easy access to the roof from the rear of the vehicle, with an integrated roller. Mounts underneath the Thule Heavy-Duty Bars, which leaves top and rear T-track free for other accessories. Can also be mounted on square bars.</p> 
---	--	--

Name	Thule Roller 334	Thule Roller 335	Thule Roller 336	Thule Roller Extension 340
Length (cm)	65	110	30	Roller 65 (frame 180 x 74)
Material	Aluminium profile, covered with soft plastic (*TPE) surface.		Aluminium profile, covered with soft plastic (*TPE) surface.	Steel frame and aluminium profile, covered with soft plastic (*TPE) surface.
Load capacity (kg)	100		100	75
TÜV approved	•		•	•
Miscellaneous	Mounts to the rear T-track of the Thule Heavy-Duty Bar. Not for use with Thule Ladder Holder 330		Mounts to the end section of the Thule Side Profile 322 only.	Mounts to the underneath of the Thule Heavy-Duty Bar. Attachment for square bars included.

Thule Accessories

<p>Thule Eye Bolt 320 Secure your load by using the Eye Bolt and the Ratchet Tie Down. Size: M 8. Material: Steel. Set of 2.</p> 	<p>Thule Ratchet Tie Down 323 Ensures speedy and secure fastening of loads, from ladders to planks. Size: 40 + 410 cm. Material: Polyester with S-hooks in steel. Tensile strength 1300 kg. Load capacity 650 kg.</p> 
---	---